



| elio |

maxi ombrellone | maxi-umbrella
großer Sonnenschirm | maxi parasol

IT

- struttura in alluminio verniciato
- componenti in nylon
- stecche in alluminio verniciato
- doppia carrucola
- tessuto e bordo in acrilico tinto in massa
- camino antivento
- **accessori p. 44**

DE

- Gestell aus pulverbeschichtetem Aluminium
- Nylon-Bestandteile
- Streben aus pulverbeschichtetem Aluminium
- Doppelter Flaschenzug
- Stoff und Saum aus düsengefärbter Acrylfaser
- Windkamin
- **Zubehör S. 44**

EN

- frame of varnished aluminium
- nylon components
- interchangeable ribs of varnished aluminium
- double pulley
- "solution dyed acrylic" fabric and border
- wind-proof chimney
- **accessories p. 44**

FR

- armature en aluminium verni
- parties en nylon
- baleines interchangeables en aluminium verni
- double poulie
- tissu et bordure en acrylique teinté masse
- soufflet de décompression
- **accessoires p. 44**

bases

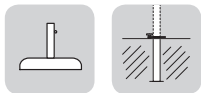

details - accessories

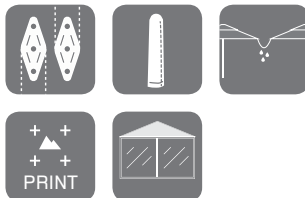

location



colours

telaio nei colori bianco e antracite
frame available in white and anthracite
Gestellfarben: Weiß und Antrazit
armature disponible en blanc et anthracite

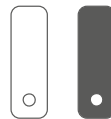

telaio
frame
Gestell
armature

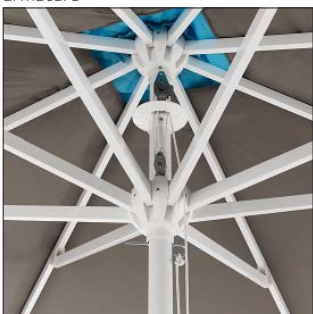

cerniera
hinge
Scharnier
charnière



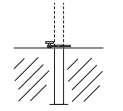
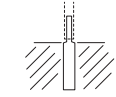
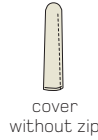
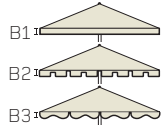
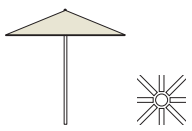

				cover without zip	base (1)/(2)	base (3)	underground base art. B52	underground base art. B53
Ø 300 cm	8	art. EL01		(200 cm)	(55 kg)	(50 kg)		
200x200 cm	4	art. EL02		(200 cm)	(55 kg)	(50 kg)		
300x300 cm	8	art. EL03		(220 cm)	(55 kg)	(50 kg)		
400x400 cm	8	art. EL04		(310 cm)	(75 kg)	-		
200x300 cm	6	art. EL05		(200 cm)	(55 kg)	(50 kg)		
300x400 cm	8	art. EL06		(270 cm)	(55 kg)	(50 kg)		

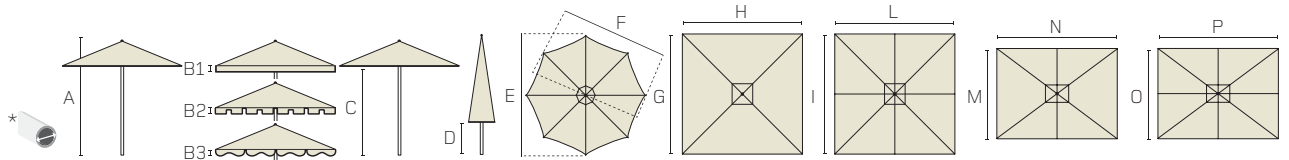

		A	B1/2/3	C	D	E/F	G/H	I/L	M/N	O/P
Ø 300 cm	55 mm	265 cm	30 cm	226 cm	110 cm	300/278 cm	-	-	-	-
200x200 cm	55 mm	265 cm	27 cm	208 cm	110 cm	-	200/200 cm	-	-	-
300x300 cm	55 mm	275 cm	30 cm	226 cm	66 cm	-	-	300/300 cm	-	-
400x400 cm	55 mm	315 cm	30 cm	251 cm	29 cm	-	-	400/400 cm	-	-
200x300 cm	55 mm	265 cm	27 cm	232 cm	81 cm	-	-	-	200/300 cm	-
300x400 cm	55 mm	285 cm	30 cm	226 cm	32 cm	-	-	-	-	300/400 cm

* sp. 2 mm

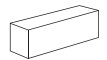

packing - volume

	kg	packing - volume
Ø 300 cm	kg. 22,00	25x280x25 h cm
200x200 cm	kg. 14,00	25x280x25 h cm
300x300 cm	kg. 25,00	30x280x30 h cm
400x400 cm	kg. 32,00	30x310x30 h cm
200x300 cm	kg. 22,00	30x280x30 h cm
300x400 cm	kg. 28,00	30x280x30 h cm

base in ghiaia lavata (1), cemento liscio (2) o cemento grigio scuro (3)
 washed gravel (1), light grey (2) or dark grey concrete base (3)
 Kiesbetonständer (1), Betonständer (2) oder Betonständer in dunkelgrau (3)
 base en gravillon lavé (1), béton lisse (2) ou béton en gris foncé (3)

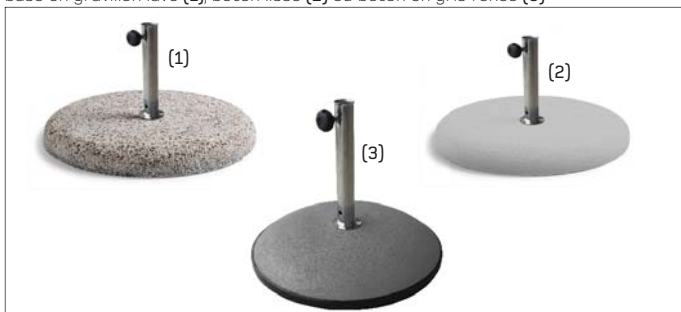

base da interrare (erba, sabbia)
 underground base (grass, sand)
 Bodenhülse (Gras, Sand)
 base à enterrer (gazon, sable)

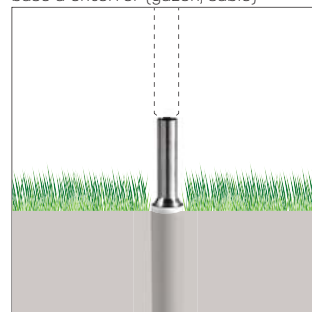

base da interrare
 underground base
 Bodenhülse zu einbetonieren
 base à enterrer

